

## 350mW, PNP Small Signal Transistor

### FEATURES

- Low power loss, high efficiency
- Ideal for automated placement
- High surge current capability
- Moisture sensitivity level: level 1, per J-STD-020
- RoHS Compliant
- Halogen-free according to IEC 61249-2-21

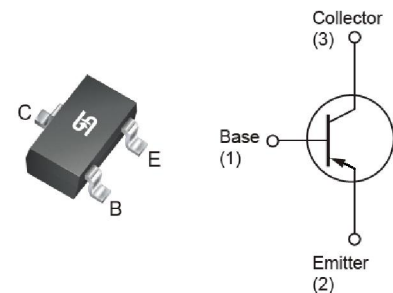
### APPLICATIONS

- Switching mode power supply (SMPS)
- Adapters
- Lighting application
- On-board DC/DC converter

### MECHANICAL DATA

- Case: SOT-23
- Molding compound meets UL 94 V-0 flammability rating
- Terminal: Matte tin plated leads, solderable per J-STD-002
- Meet JESD 201 class 1A whisker test
- Weight: 0.008g(approximately)

KEY PARAMETERS		
PARAMETER	VALUE	UNIT
$V_{CBO}$	-40	V
$V_{CEO}$	-40	V
$V_{EBO}$	-5	V
$I_C$	-200	mA
$h_{FE}$	300	
Package	SOT-23	
Configuration	Single Die	



ABSOLUTE MAXIMUM RATINGS ( $T_A = 25^\circ\text{C}$ unless otherwise noted)			
PARAMETER	SYMBOL	MMBT3906	UNIT
Marking code on the device		2A	
Collector-base voltage	$V_{CBO}$	-40	V
Collector-emitter voltage	$V_{CEO}$	-40	V
Emitter-base voltage	$V_{EBO}$	-5	V
Collector current, dc	$I_C$	-200	mA
Power dissipation	$P_D$	350	mW
Junction temperature	$T_J$	-55 to +150	$^\circ\text{C}$
Storage temperature	$T_{STG}$	-55 to +150	$^\circ\text{C}$

<b>THERMAL PERFORMANCE</b>			
<b>PARAMETER</b>	<b>SYMBOL</b>	<b>TYP</b>	<b>UNIT</b>
Junction-to-ambient thermal resistance	$R_{\theta JA}$	357	$^{\circ}C/W$

<b>ELECTRICAL SPECIFICATIONS</b> ( $T_A = 25^{\circ}C$ unless otherwise noted)					
<b>PARAMETER</b>	<b>CONDITIONS</b>	<b>SYMBOL</b>	<b>MIN</b>	<b>MAX</b>	<b>UNIT</b>
Collector-base breakdown voltage	$I_C = -10 \mu A, I_E = 0$	$V_{(BR)CBO}$	-40	-	V
Collector-emitter breakdown voltage	$I_C = -1 mA, I_B = 0$	$V_{(BR)CEO}$	-40	-	V
Emitter-base breakdown voltage	$I_E = -10 \mu A, I_C = 0$	$V_{(BR)EBO}$	-5	-	V
Collector base cutoff current	$V_{CB} = -40 V$	$I_{CBO}$	-	-100	nA
Emitter base cutoff current	$V_{EB} = -6 V$	$I_{EBO}$	-	-50	nA
DC current gain	$V_{CE} = -1 V, I_C = -0.1 mA$	$h_{FE}$	60	300	
	$V_{CE} = -1 V, I_C = -1 mA$		80		
	$V_{CE} = -1 V, I_C = -10 mA$		100		
	$V_{CE} = -1 V, I_C = -50 mA$		60		
	$V_{CE} = -1 V, I_C = -100 mA$		30		
Collector-emitter saturation voltage	$I_C = -10 mA, I_B = -1 mA$	$V_{CE(sat)}$	-	-0.25	V
	$I_C = -50 mA, I_B = -5 mA$		-	-0.4	
Base-emitter saturation voltage	$I_C = -10 mA, I_B = -1 mA$	$V_{BE(sat)}$	-0.65	-0.85	V
	$I_C = -50 mA, I_B = -5 mA$		-	-0.95	
Transition frequency	$V_{CE} = -20 V, I_C = -10 mA,$ $f = 100MHz$	$f_T$	250	-	MHz
Output capacitance	$f = 1MHz, V_{CB} = -5 V,$ $I_E = 0$	$C_{OBO}$	-	4.5	pF
Delay time	$V_{CC} = -3V, V_{BE} = -0.5V,$ $I_C = -10mA$	$t_d$	-	35	ns
Rise time	$I_{B1} = -1mA$	$t_r$	-	35	ns
Storage time	$V_{CC} = -3V, I_C = -10mA$	$t_s$	-	225	ns
Fall time	$I_{B1} = I_{B2} = -1mA$	$t_f$	-	75	ns

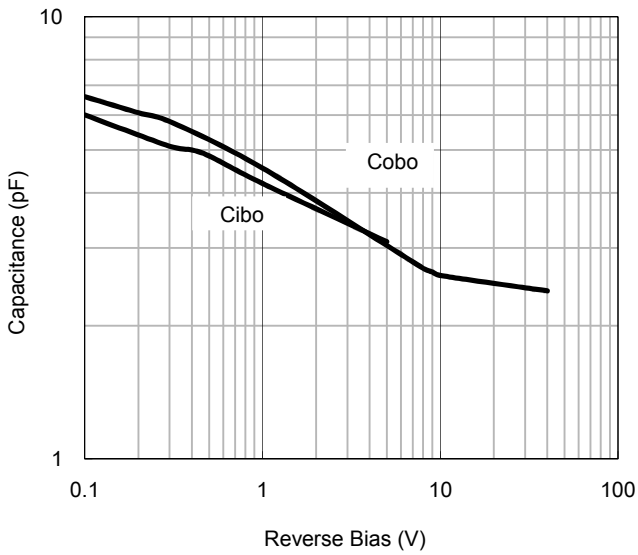
<b>ORDERING INFORMATION</b>		
<b>ORDERING CODE</b>	<b>PACKAGE</b>	<b>PACKING</b>
MMBT3906 RF	SOT-23	3K / 7" Reel
MMBT3906 RFG	SOT-23	3K / 7" Reel
MMBT3906 R5	SOT-23	10K / 13" Reel
MMBT3906 R5G	SOT-23	10K / 13" Reel

**Note:** "G" means green compound (halogen free)

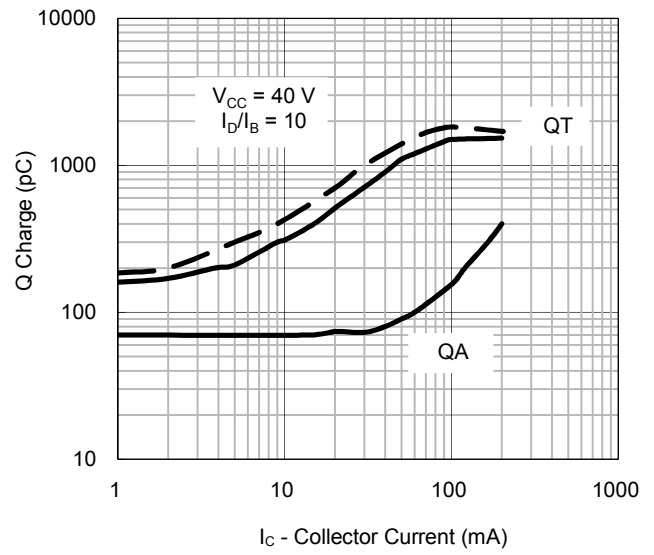
**CHARACTERISTICS CURVES**

( $T_A = 25^\circ\text{C}$  unless otherwise noted)

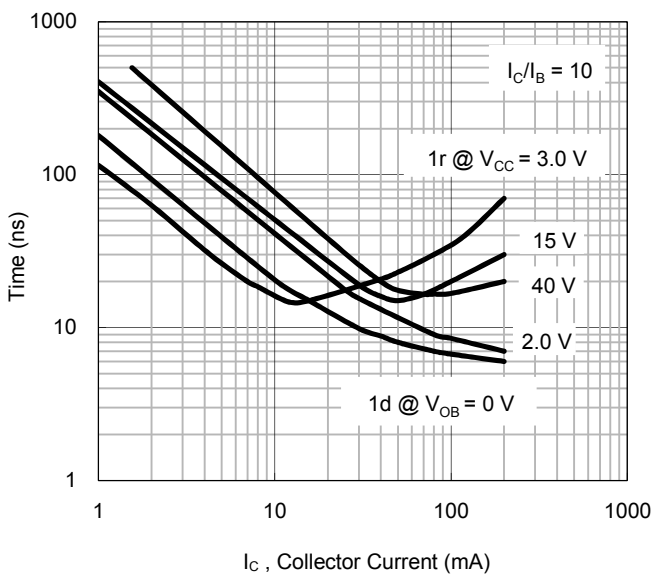
**Fig.1 Capacitance**



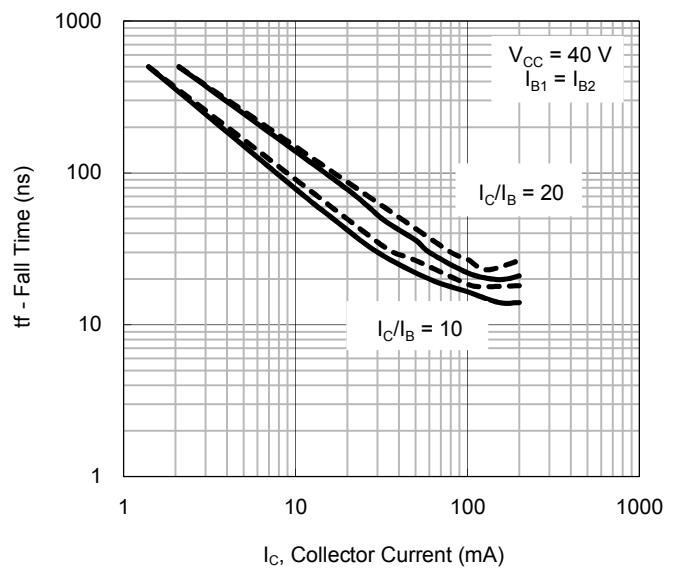
**Fig.2 Charge Data**



**Fig.3 Turn - On Time**



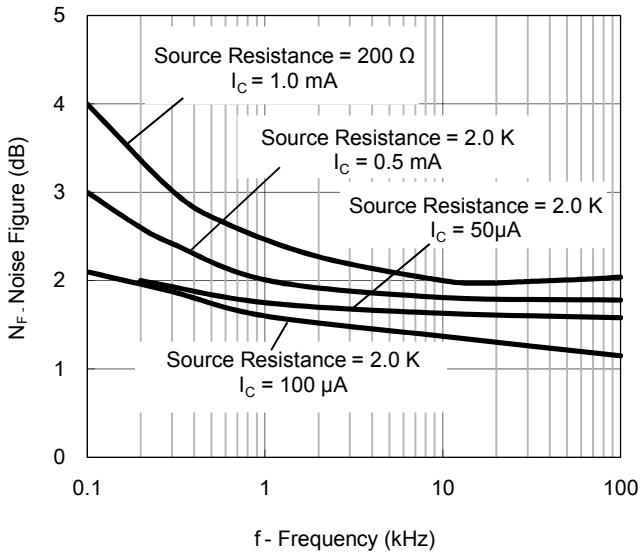
**Fig.4 Fall Time**



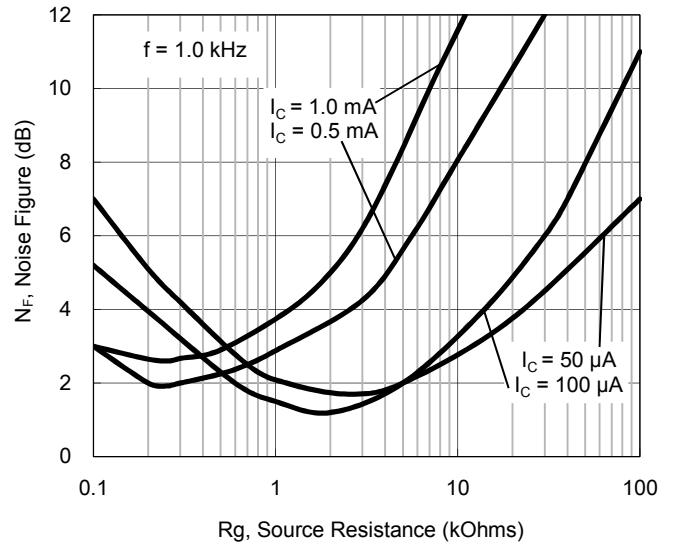
**CHARACTERISTICS CURVES**

( $T_A = 25^\circ\text{C}$  unless otherwise noted)

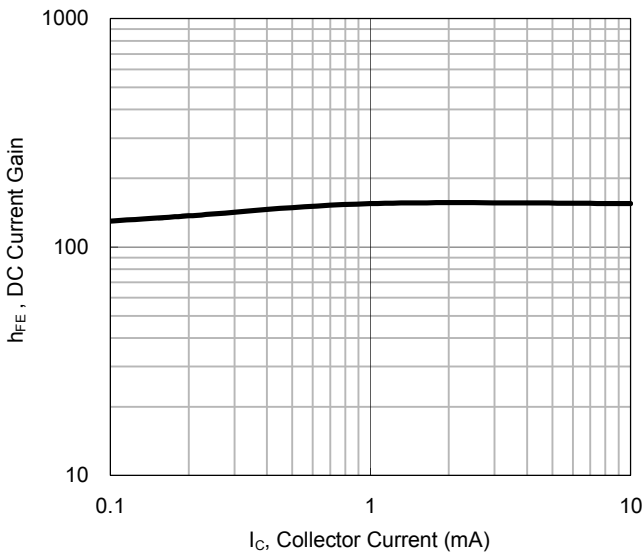
**Fig.5 Noise Figure VS. Frequency**



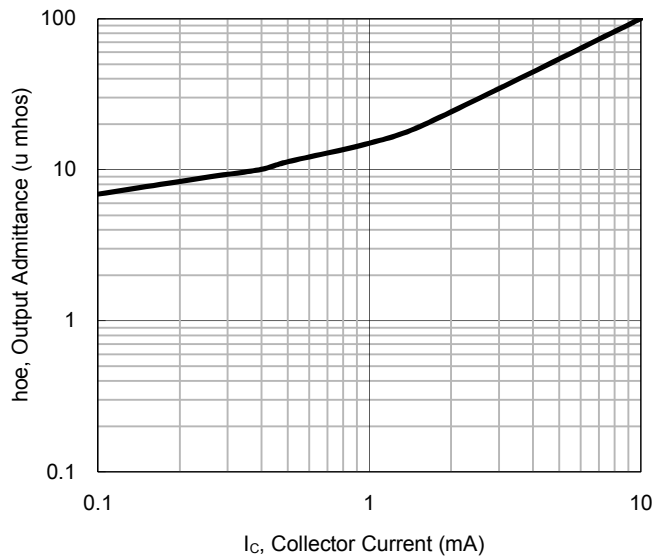
**Fig.6 Noise Figure VS. Source Resistance**



**Fig.7 Current Gain**



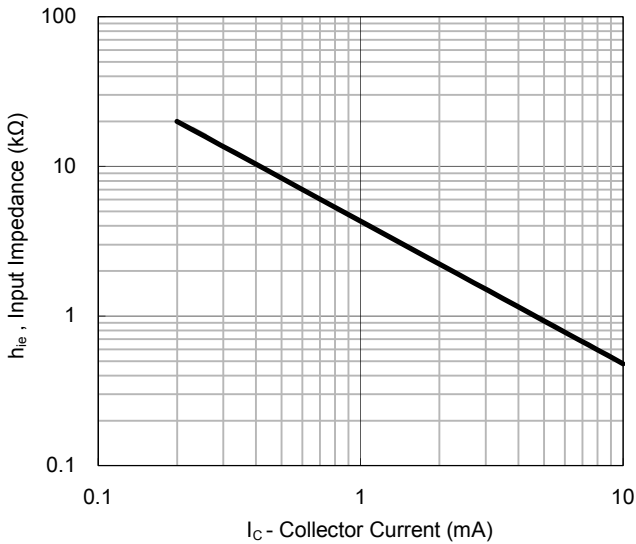
**Fig.8 Output Admittance**



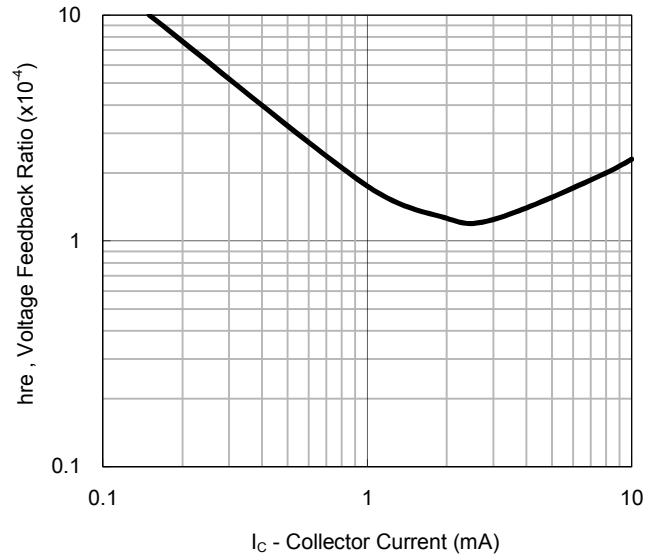
**CHARACTERISTICS CURVES**

( $T_A = 25^\circ\text{C}$  unless otherwise noted)

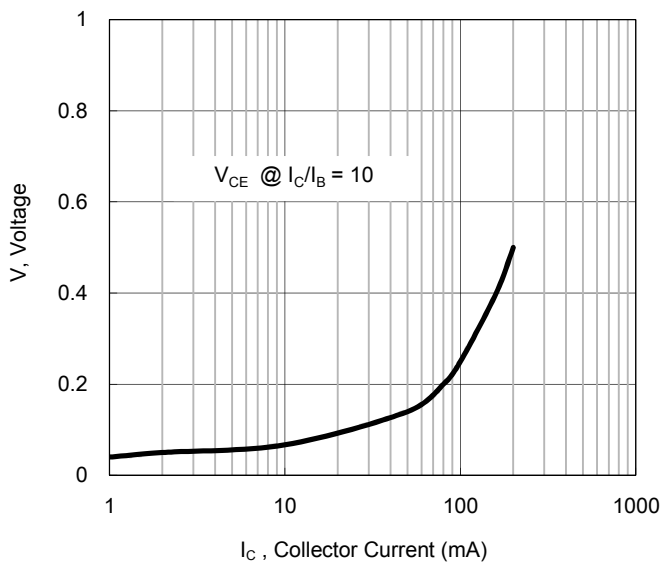
**Fig.9 Input Impedance**



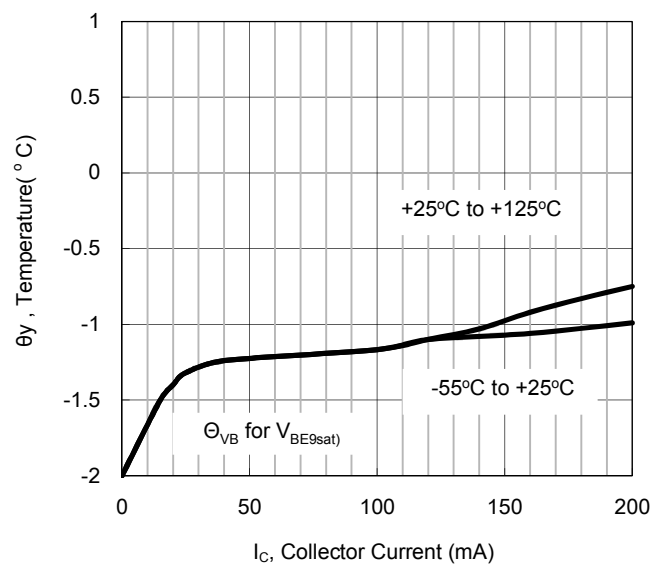
**Fig.10 Voltage Feedback Ratio**



**Fig.11 "ON" Voltages**

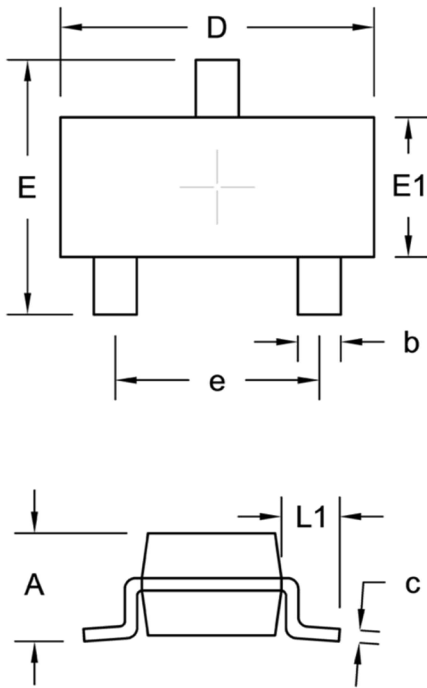


**Fig.12 Temperature Coefficients**



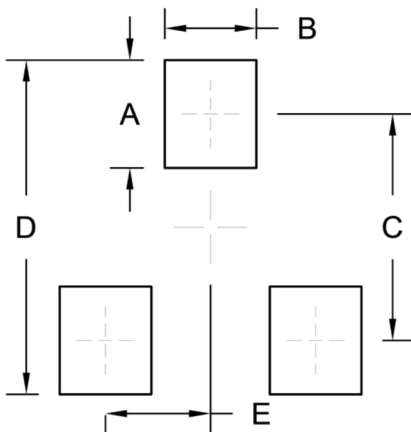
**PACKAGE OUTLINE DIMENSION**

SOT-23



DIM.	Unit (mm)		Unit (inch)	
	Min.	Max.	Min.	Max.
A	0.89	1.12	0.035	0.044
b	0.30	0.50	0.012	0.020
c	0.08	0.20	0.003	0.008
D	2.80	3.04	0.110	0.120
E	2.10	2.64	0.083	0.104
E1	1.20	1.40	0.047	0.055
e	1.90 BSC		0.075 BSC	
L1	0.54 REF.		0.021 REF.	

**SUGGESTED PAD LAYOUT**



Symbol	Unit (mm)	Unit (inch)
A	1.00	0.039
B	0.85	0.033
C	2.10	0.083
D	3.10	0.122
E	0.98	0.039

## Notice

Specifications of the products displayed herein are subject to change without notice. TSC or anyone on its behalf, assumes no responsibility or liability for any errors or inaccuracies.

Purchasers are solely responsible for the choice, selection, and use of TSC products and TSC assumes no liability for application assistance or the design of Purchasers' products.

Information contained herein is intended to provide a product description only. No license, express or implied, to any intellectual property rights is granted by this document. Except as provided in TSC's terms and conditions of sale for such products, TSC assumes no liability whatsoever, and disclaims any express or implied warranty, relating to sale and/or use of TSC products including liability or warranties relating to fitness for a particular purpose, merchantability, or infringement of any patent, copyright, or other intellectual property right.

The products shown herein are not designed for use in medical, life-saving, or life-sustaining applications. Customers using or selling these products for use in such applications do so at their own risk and agree to fully indemnify TSC for any damages resulting from such improper use or sale.